

PHOENIX ADAS MOBILE PRODUCT PROFILE



TOPDON®

WHAT IS ADAS?

- The Advanced Driver Assistance System (ADAS) uses image processing cameras, radar, light detection, ranging, and other sensors to monitor vehicle surroundings and detect potentially dangerous situations.
- Its purpose is to increase safety through advanced situational awareness and reduce collision possibilities.
- ADAS Sensors include Cameras, Radar, LiDAR, Night Vision, and Ultrasonic sensors. These sensors work with other vehicle systems to monitor the vehicle's state, motion, and stability. Usually, these sensors are located in the front and rear bumpers, side mirrors, front grille, and windshield glass.



WHAT ARE THE APPLICATIONS OF ADAS?

- Most ADAS systems include Traffic Message Channel (TMC), Intelligent Speed Adaptation (ISA), Vehicular Communication Systems, and other driver assistant systems.

The specific systems are as follows:

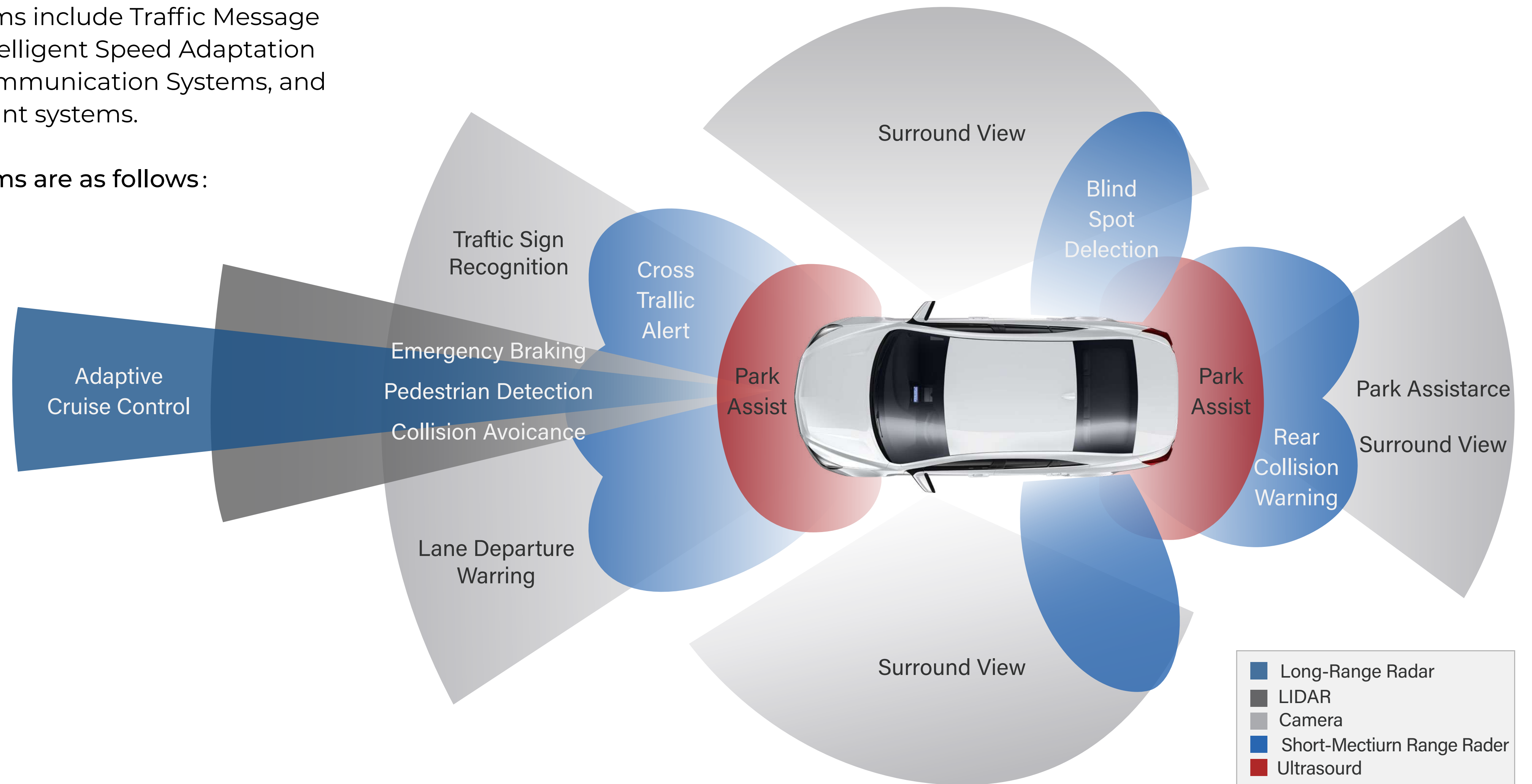

TYPES OF SYSTEMS

Passive Assist Systems

- Passive ADAS systems monitor the environment around the vehicle. These systems warn the driver through lights, message centers, audible beeps and/or deliberately vibrating parts of the car, like the seats, steering wheel, brake pedals, or even the seat belts.
- Passive systems will also use live camera displays or live graphics to assist the driver. These camera displays include:

LDW – Lane Departure Warning
RCW – Rear Collision Warning
AVM – Around View Monitoring
BSD – Blind Spot Detection
FCW – Front Collision Warning
NVS – Night Vision System

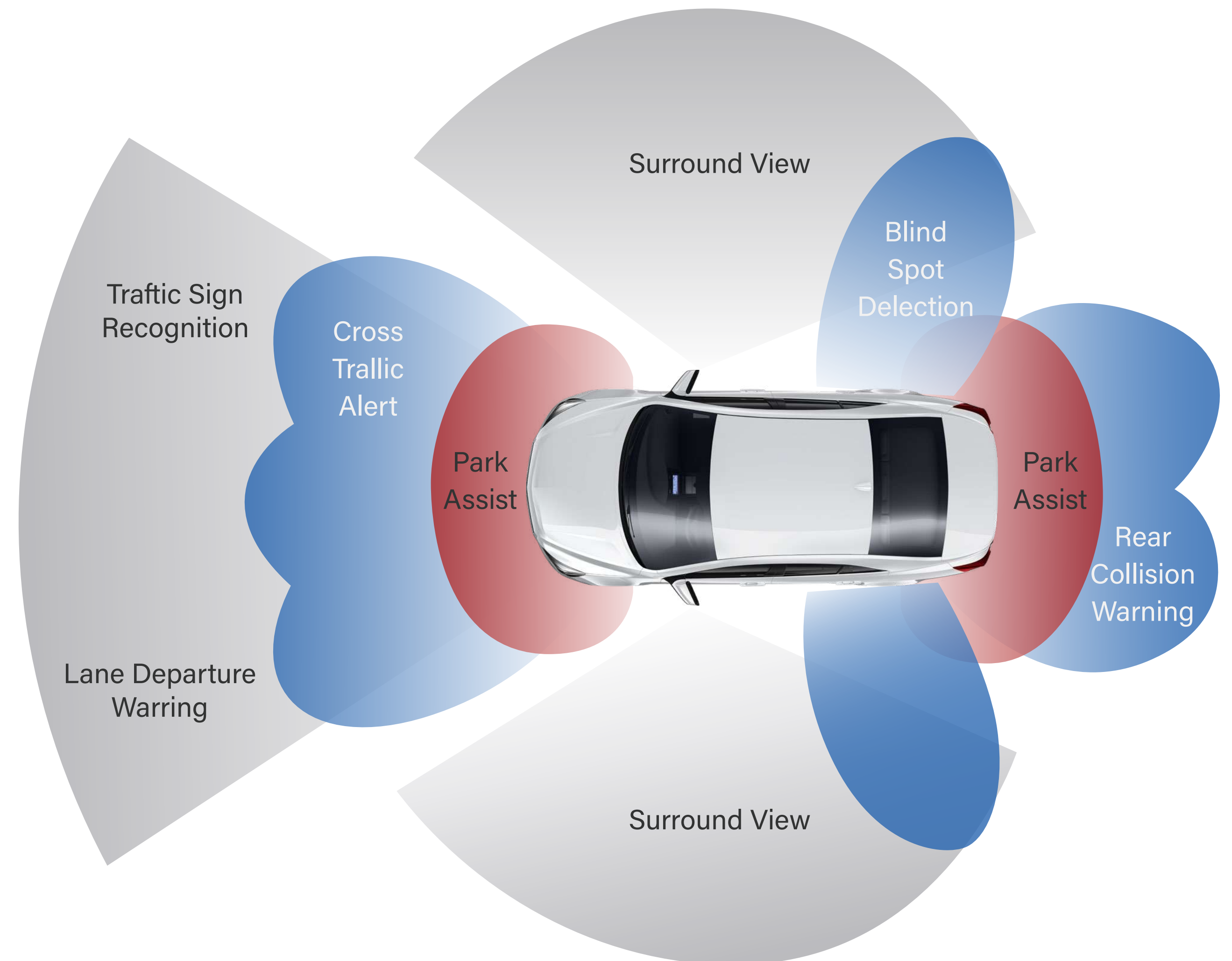

TYPES OF SYSTEMS

Active Assist Systems

▪ Active ADAS systems will slow, stop or turn the vehicle from an object or situation (like lane departure) using the electronic power steering module, electronic braking, ABS modules, and throttle controls in the Powertrain Control Module (PCM). Active Assist Systems can also use sensors to park a vehicle without the driver or adjust headlights to steering inputs.

- AEB – Automatic Emergency Braking
- ACC – Adaptive Cruise Control
- LKA – Lane Keep Assist
- AFL – Adaptive Front Lighting
- AP – Assisted or Automatic Parking
- FCA – Front Collision Avoidance

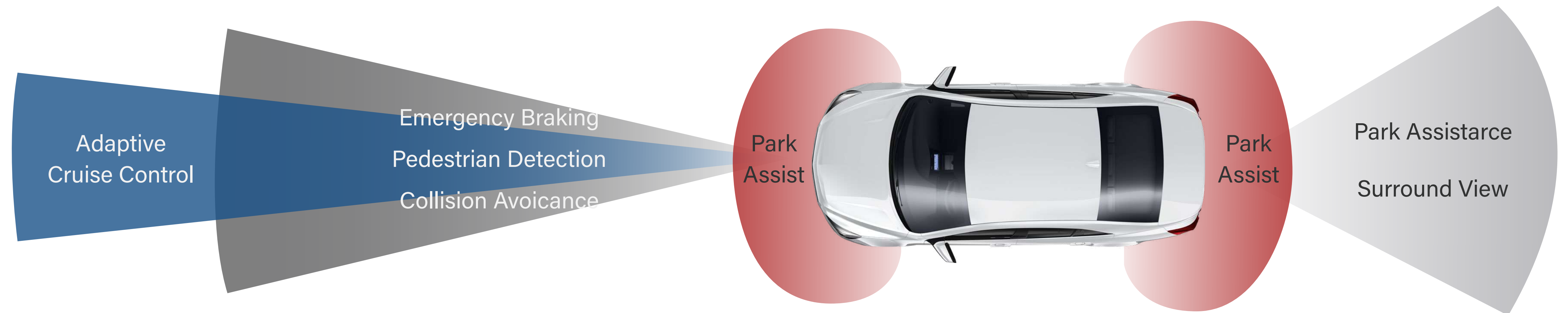

WHAT WARRANTS AN ADAS RECALIBRATION?



Collision Repair



Replacing Windows, Hood, or Trunk



Removing a Front or Rear Bumper

Other Common Causes For Recalibration

- Mirror Replacement
- Suspension Work or Suspension Replacements, including Alignments
- “Curbing” or Bumping a Moving Sensor Module
- A Module Replacement or Component Replacement
- Loss of calibration data

PHOENIX ADAS MOBILE

- The Phoenix ADAS Mobile is a foldable calibration frame that offers unmatched portability and convenience, making auto shops even more productive and profitable.

- Compatible with TOPDON's Phoenix Series of diagnostic scanners, this device gives professionals the capability to provide needed work on the most modern cars.

- This is a must-have tool for professional collision shops, components, and parts specialists, as well as any auto body shop that provides services such as window, trunk, and bumper cover replacement, wheel alignment, suspension, and and more!



SPECS

The Phoenix ADAS Mobile comes safely packaged in a Wooden Case

Measurements

3.8*3.6*2.0 (inch)

Weight

308lb/140kg

Package includes

The ADAS Mobile, main case, an accessory case, a small targets case, and a modern LAM01-09 target case

Large targets are shipped separately in Carton Packaging

Measurements

4.5*0.3*3.3(inch)

Weight

39lb/18kg

Package includes

VW LAM01-02 target, Subaru LAM01-15 target, Subaru 2 LAM01-21 target

IT'S BEST FEATURES

- Collapsible Design For Easy Storage
- Highly Precise Five-Axis Laser for Accurate Calibration
- Easy Center-Positioning for Micro-Adjustments
- Covers a Wide Range of Car Makes with Various OE-size targets
- Intuitive User Interface (UI) provides Detailed Steps and Illustrations



TOTALLY MOBILE

Featuring a multifunctional base with 360-degree swivel wheels, the Phoenix ADAS Mobile allows you to adjust the height and make adaptations to calibrate when working on uneven ground.

Professionals equipped with this device can calibrate ADAS passive and active systems on any flat surface: an auto shop, a parking lot, or even at a client's driveway.



CONVENIENT STORAGE

The Phoenix ADAS Mobile features a collapsible design for convenience, easy storage, and unmatched portability. With foldable arms and folding base legs, this tool can fit in nearly any vehicle's trunk.

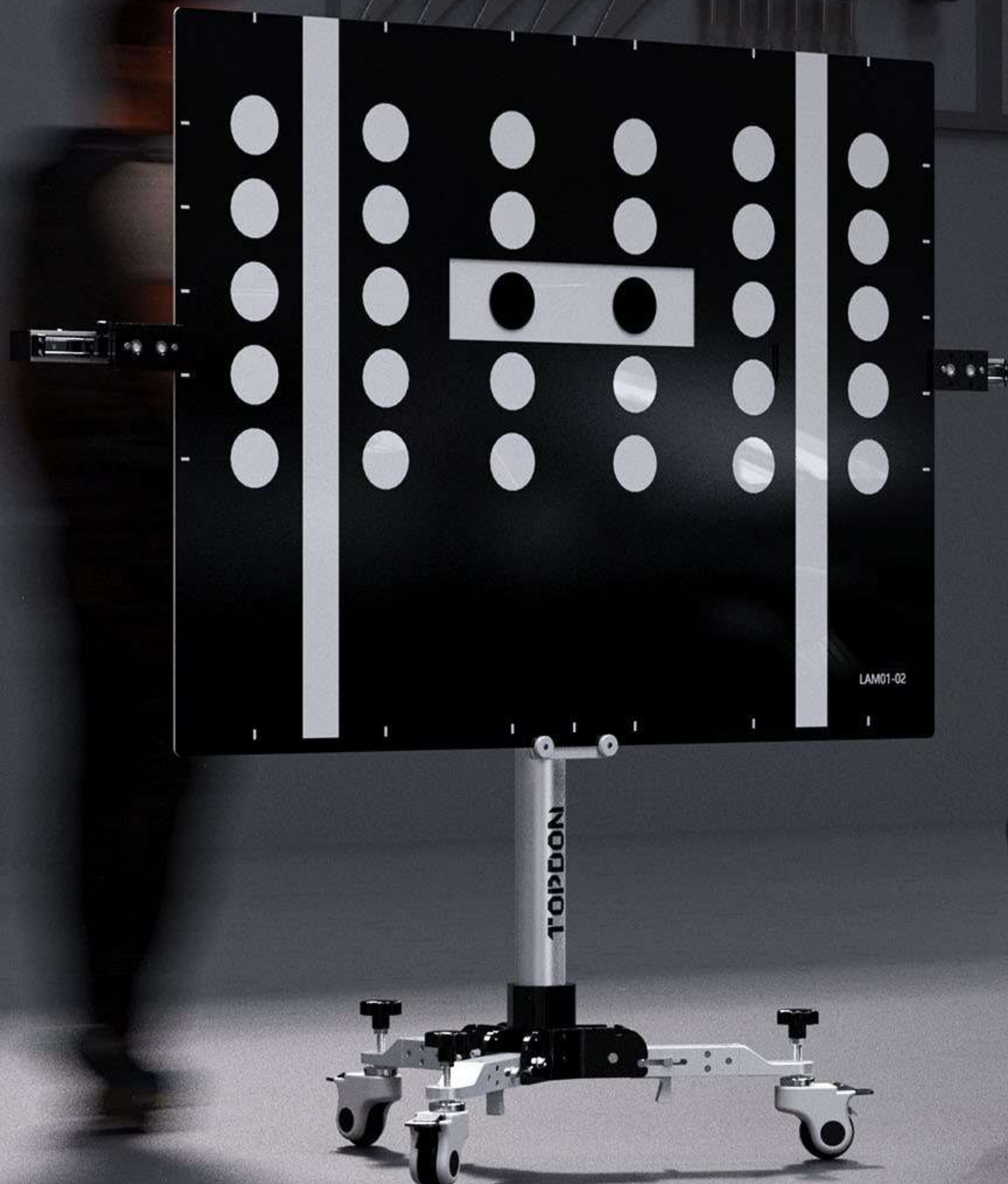

QUICK SET UP

Experienced technicians can quickly set up the Phoenix ADAS Mobile and start the job in 30 minutes. Easily put away this fully collapsible tool, making your shop more productive and profitable.



A black SUV is parked in a garage. To the left, a white ADAS calibration tool on wheels is positioned. The tool has a vertical pole and a horizontal arm. Five green laser lines are projected from the tool: one from the top arm to the windshield, one from the top arm to the hood, one from the bottom arm to the front bumper, one from the bottom arm to the front wheel, and one from the bottom arm to the ground. In the background, there are metal racks filled with tires.

GET UNMATCHED PRECISION

A high-precision 5-lasers device will assist you to position the ADAS calibration tool with exactness.

The easy center-positioning lets you promote micro-adjustments effortlessly for even more accurate calibration services.

EVEN MORE COVERAGE!

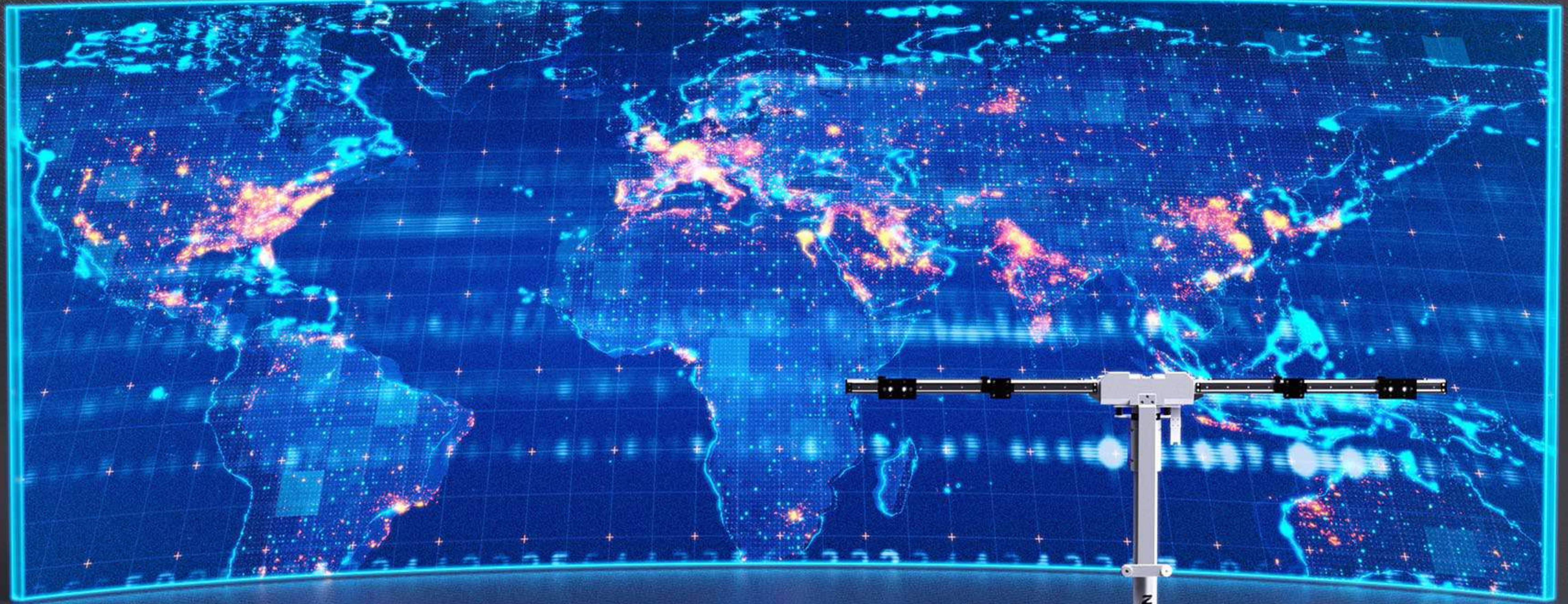

The Phoenix ADAS Mobile covers most US, European, and Asian car brands, including a wide variety of targets. As more ADAS-capable vehicles come out, TOPDON consistently updates its inventory to offer targets to match them.

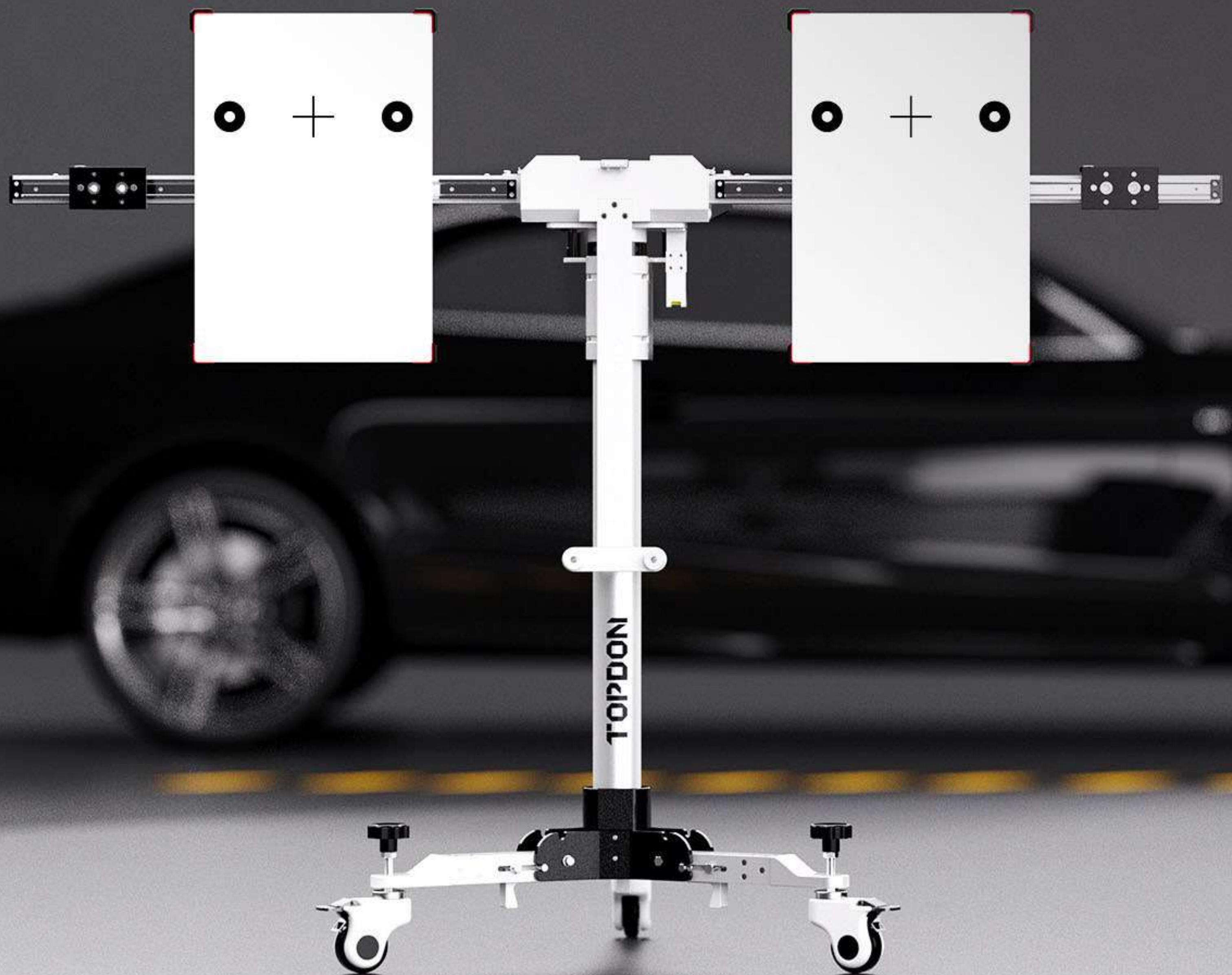

EASY-TO-USE STEP-BY-STEP PROCEDURES



TOPDON's Phoenix ADAS Mobile is compatible with the entire Phoenix Series of Diagnostic Scanners. Featuring an intuitive interface, the software provides its users' detailed steps, illustrations, and real-time guided operation.

WHAT'S IN THE BOX?

PX 1000 Calibration Frame

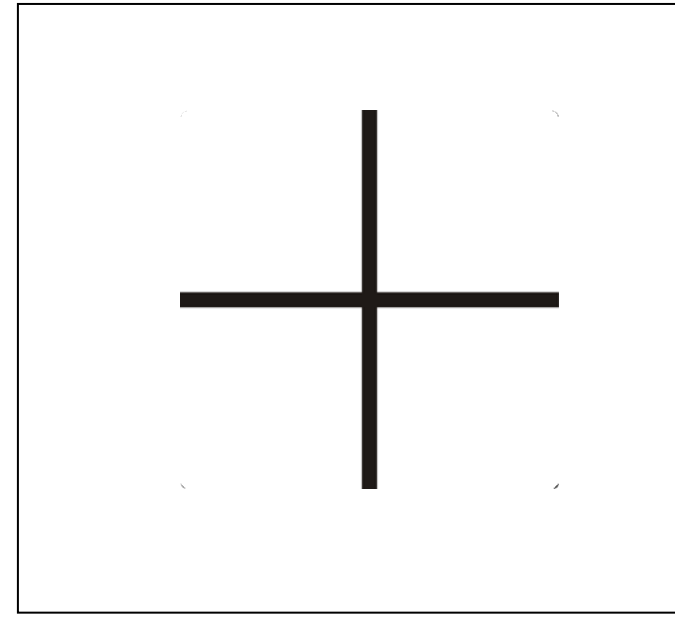

Cross Sticker



Five Line Laser
LAM09-01



Cross Laser
LAM09-02



Laser Reflector
LAM09-03



Tape

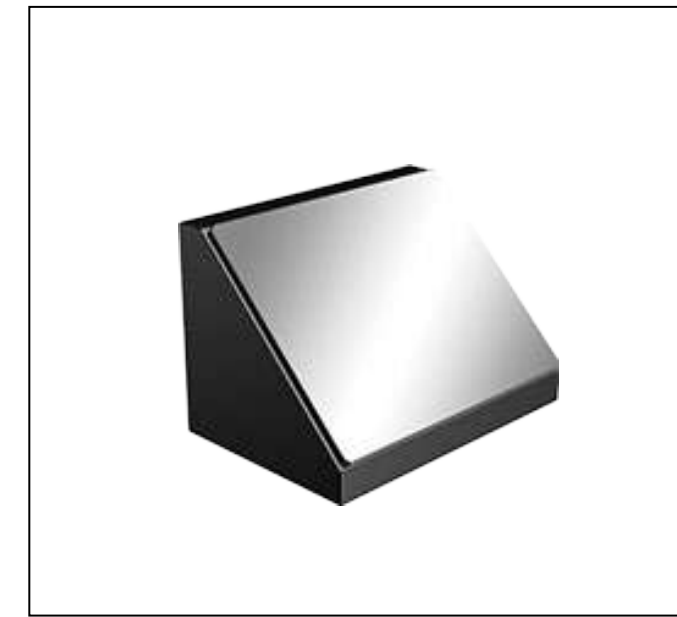

Auxiliary Mirror
LAM09-04



L-Type Positioning Bracket
LAM09-05



Lead Hammer
LAM09-06



Unfolding



After folding

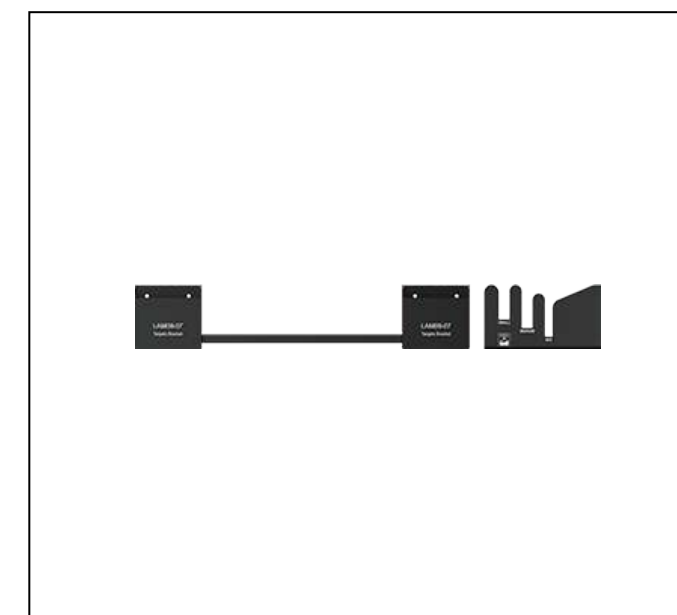

Targets Storage Bracket
LAM09-07



Targets Extension Rod
LAM09-08

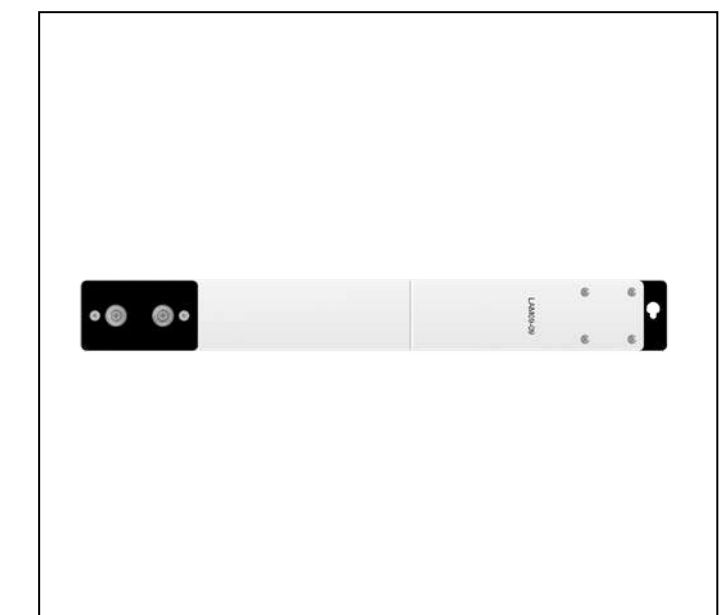

Targets Extension Rod II
LAM09-09

LDW Targets (Large Targets)

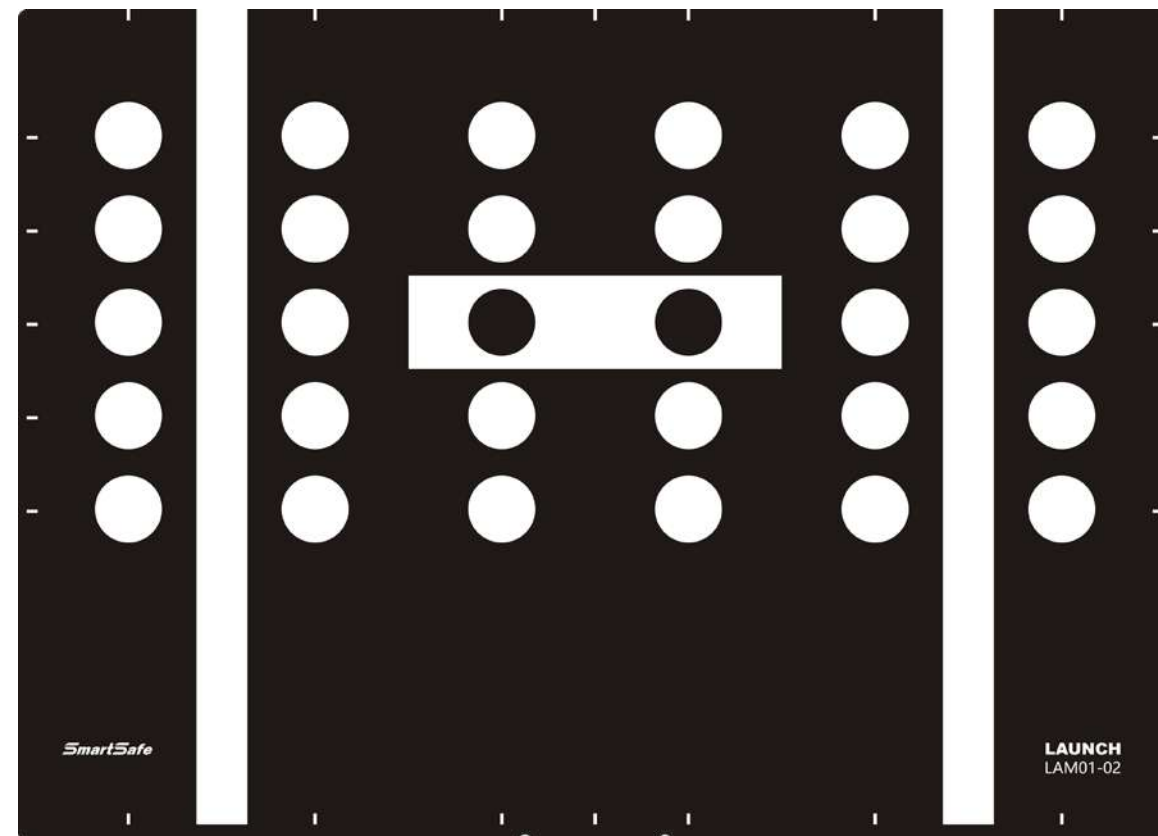

▪ VW/Audi LAM01-02

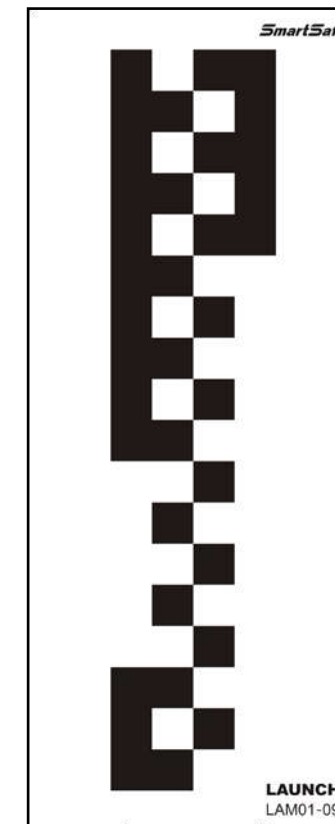

▪ Hyundai/Kia LAM01-09

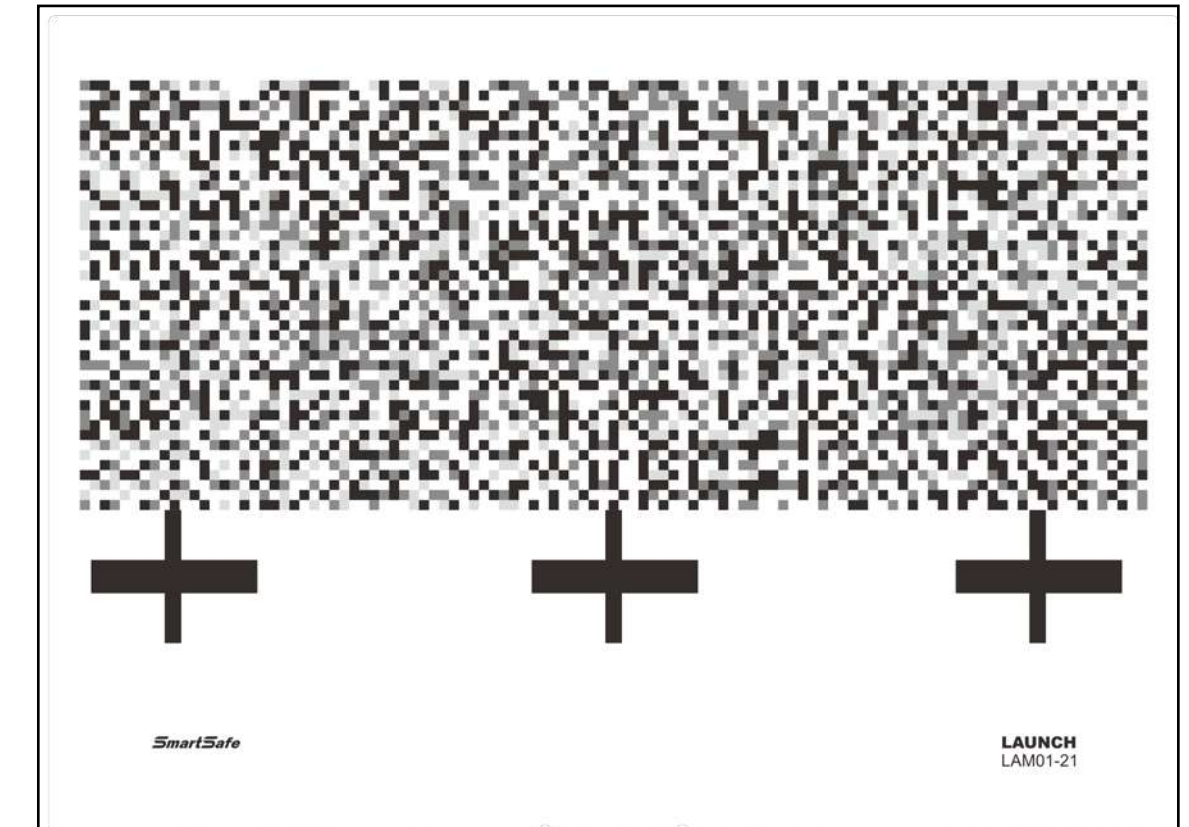

▪ Subaru-LDW LAM01-2



▪ Subaru LAM01-15

LDW Targets (Small Targets)

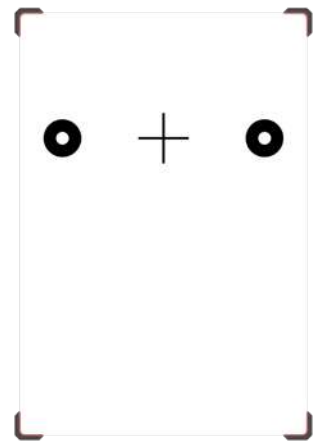

BenzLAM
01-01



MazdaLAM
01-10



Hyundai/KiaLAC
01-13



HondaLAM
01-20

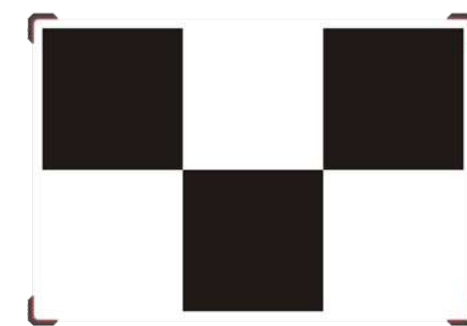

HondaLAM
01-04-L

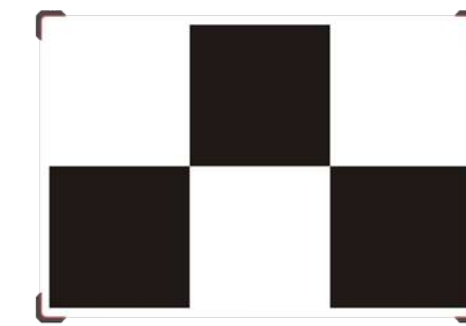

Honda LAM
01-04-R

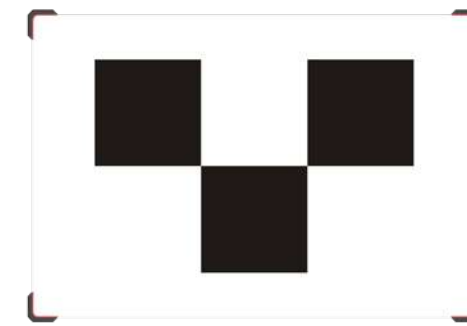

NissanLAM
01-07-L

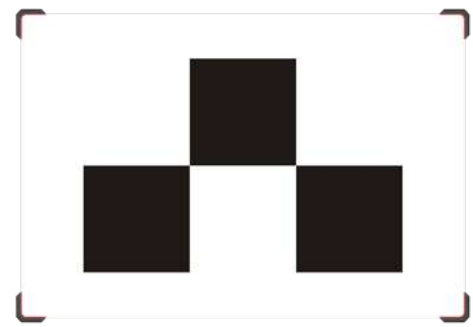

NissanLAM
01-07-R

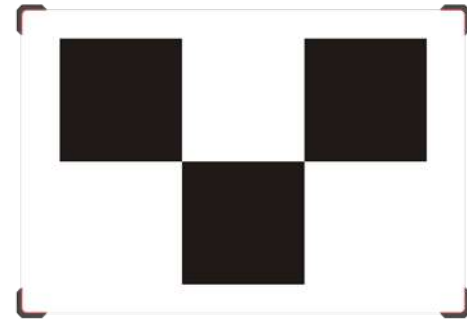

MazdaLAM
01-16-L

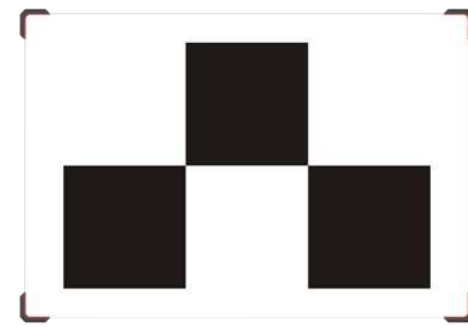

MazdaLAM
01-16-R

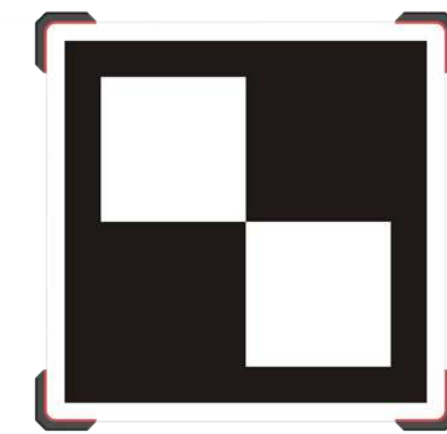

MitsubishiLAM
01-19-R

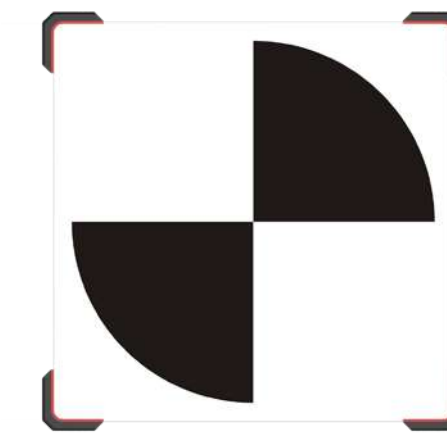

Renault/NissanLAM
01-12-L

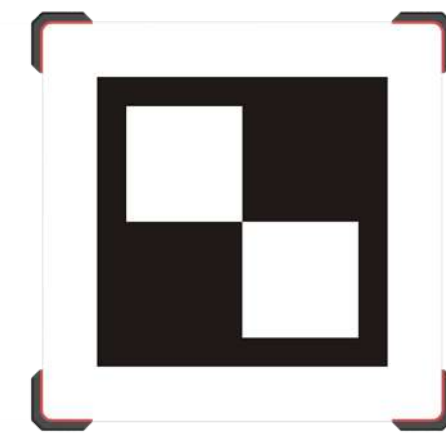

ToyotaLAM
01-06-1

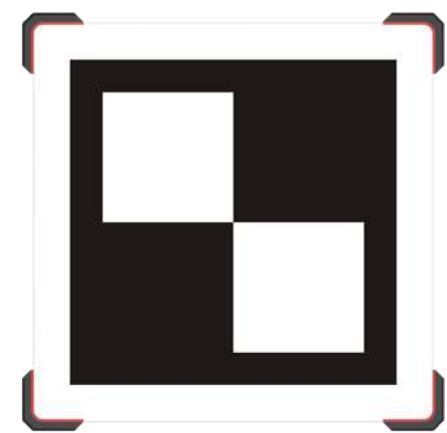

ToyotaLAM
01-06-2

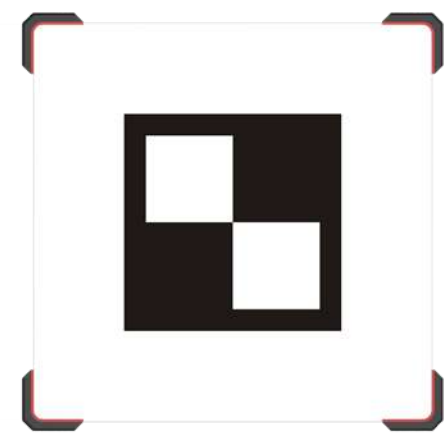

ToyotaLAM
01-06-3

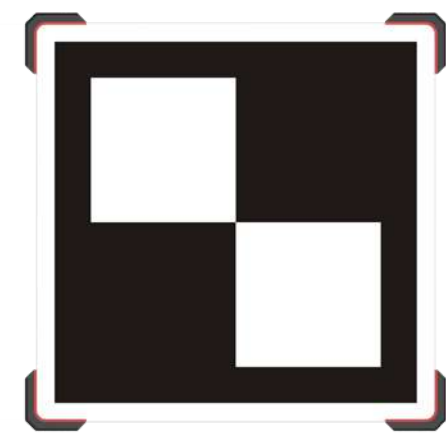

MitsubishiLAM
01-19-L



HondaLAM
01-17

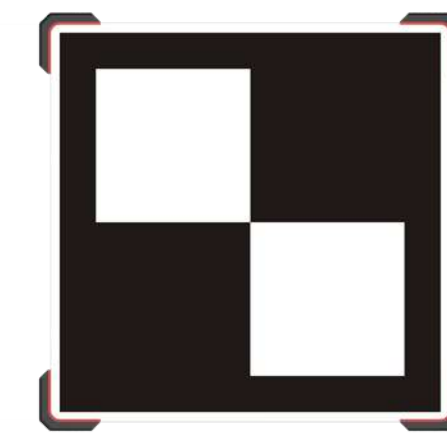

SuzukiLAM
01-18-L

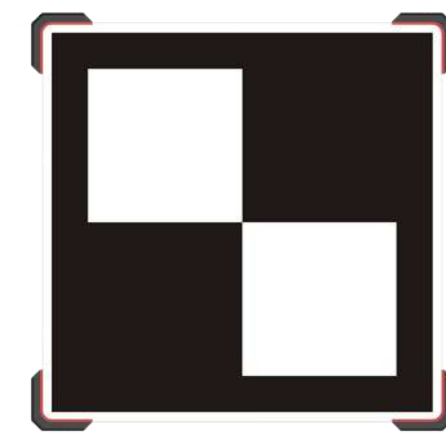

SuzukiLAM
01-18-R

Expand your capabilities

*Additional Target Available for Purchase



(LAC05-03) Corner Reflector, ACC/BSD

Coverage:

Toyota, Honda, Lexus, Mazda, Subaru, Mitsubishi

Package Size:

513*462*328mm (20*18*13 inch)

Weight:

12kg (26 ib)

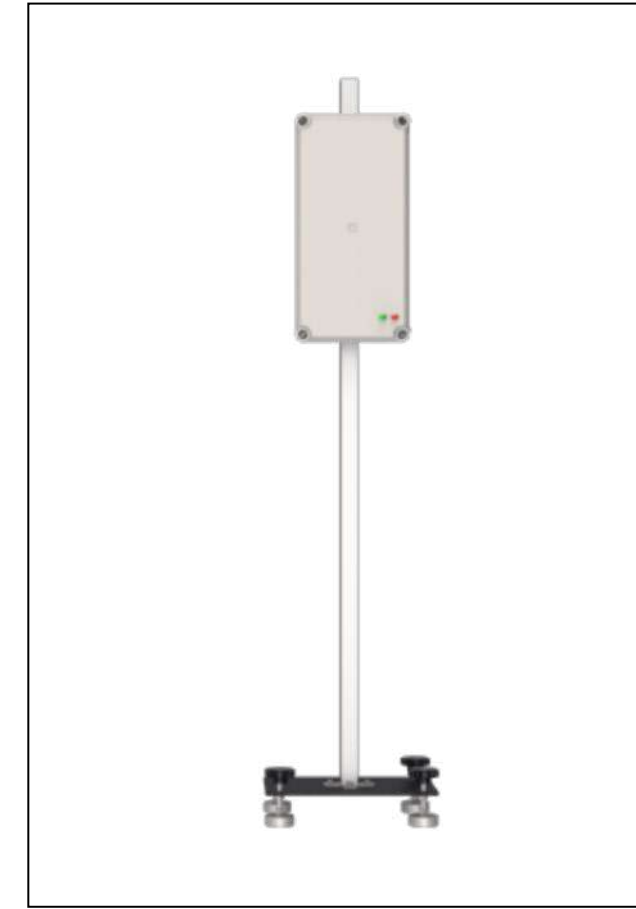

(LAC05-04) Doppler Simulator, BSD

Coverage:

VW, Audi, Skoda

Package Size:

1260*300*170mm (50*12*7 inch)

Weight:

7.8 kg (17 ib)

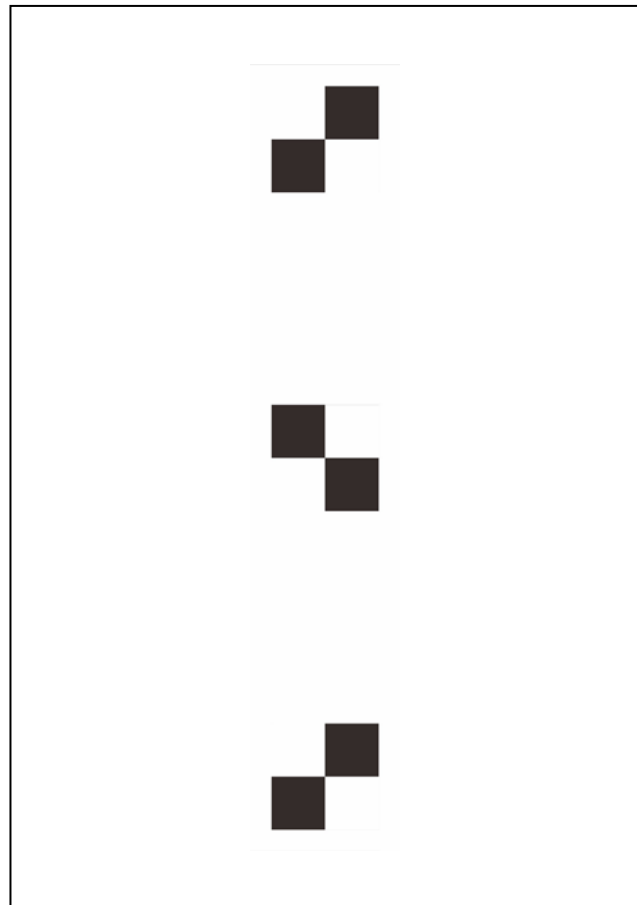

(LAC04-15) Nissan AVM Panels, Nissan-RCW

Coverage:

Nissan, Infiniti

Package Size:

730*80*80mm (29*3*3 inch)

Weight:

1.6 kg (4 ib)

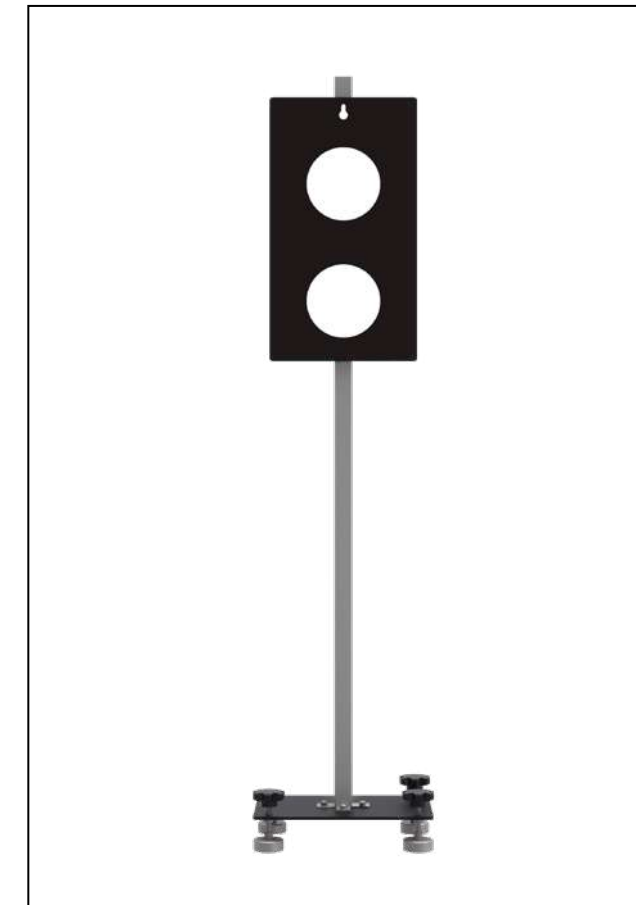

(LAC04-14) VW AVM Panels, VW-AVM

Coverage:

VW, Audi

Package Size:

1260*260*235mm (50*10*9 inch)

Weight:

14 kg (31 ib)

(LAC04-13) Mitsubishi AVM Panels, AVM

Coverage:
Alfa Romeo

Package Size:
1032*146*80mm (55*2*39 inch)

Weight:
4 kg (18 ib)

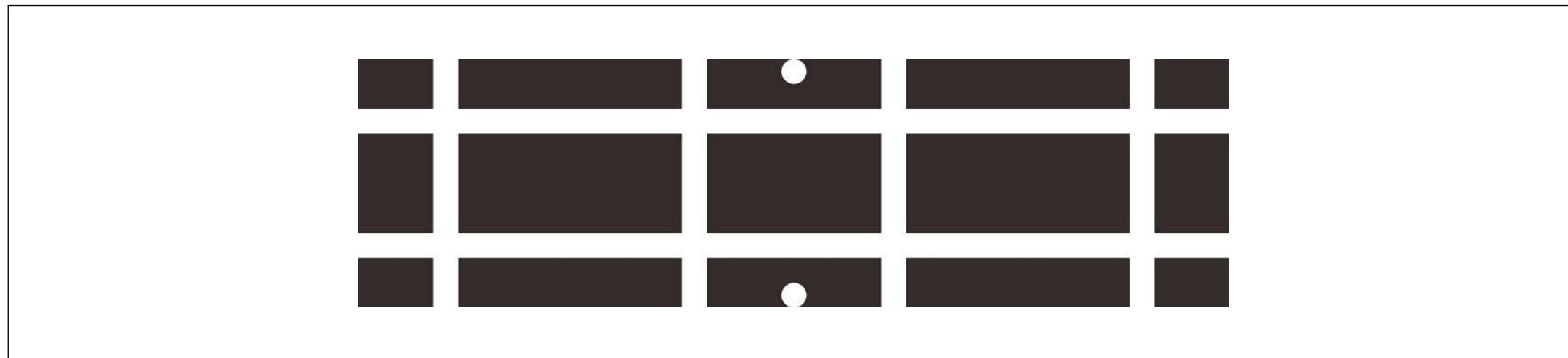

(LAM01-11) Romeo Nissan Single Target, LDW

Coverage:
Alfa Romeo

Package Size:
1390*60*1000mm (55*2*39 inch)

Weight:
8.1 kg (18 ib)

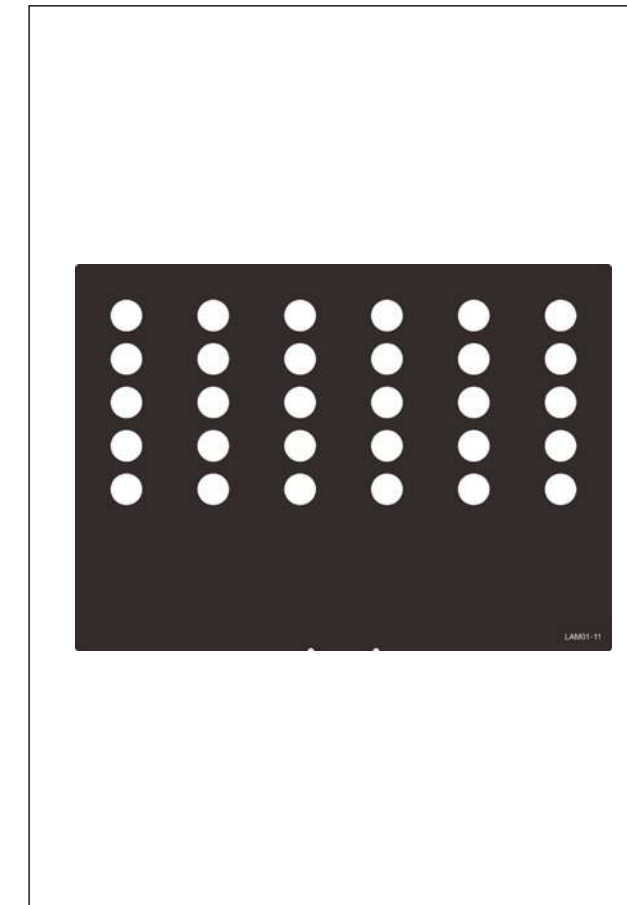

(LAM05-02) ACC Target

Coverage:
VW, Audi, Skoda, Seat, BMW, Rolls Royce,
Porsche, Jeep, Romeo, Mini, Hyundai, Kia,
Nissan, Infiniti, Mitsubishi, Suzuki.

Package Size:
513*462*328mm (20*18*13 inch)

Weight:
12 kg (26 ib)



Rear Camera & AVM Panels (American)

Coverage:
Ford, Cadillac

Package Size:
1706x320x129mm (67*13*5 inch)

Weight:
24.5kg (54 ib)

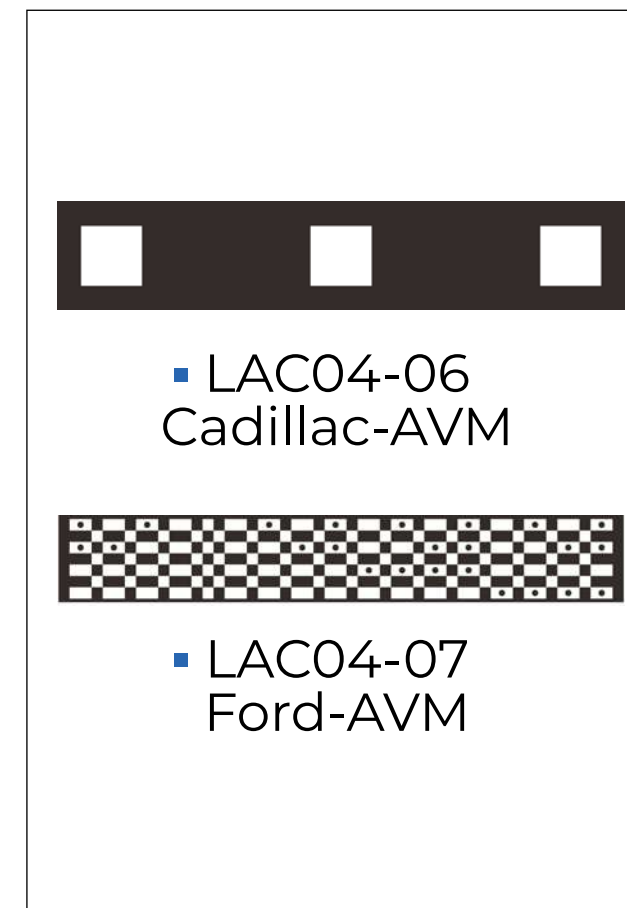

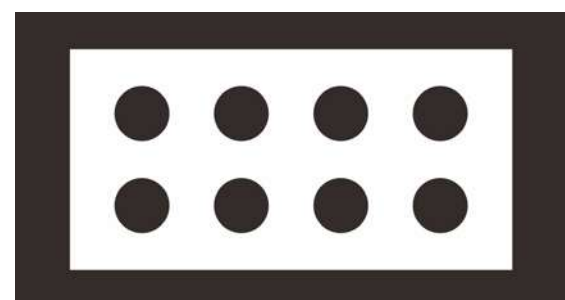

▪ LAC02-02 Mercedes-RCW



▪ LAC04-02 Honda-AVM



▪ LAC04-13 Mitsubishi-AVM

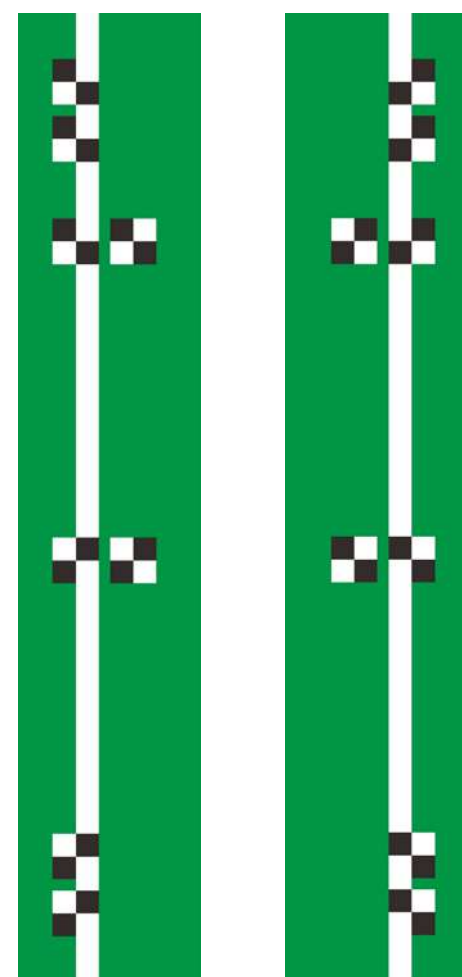

▪ LAC04-12-01 Hyundai-AVM
▪ LAC04-12-02 Hyundai-AVM

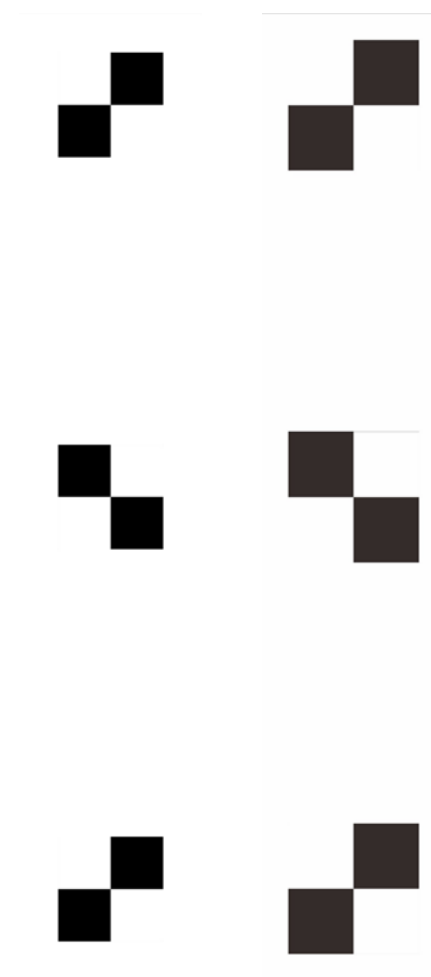

▪ LAC04-11 Nissan-RCW
▪ LAC04-15 Nissan-RCW

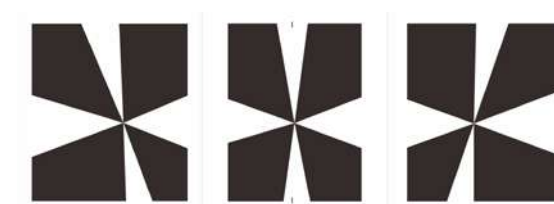

▪ LAC02-02 Mercedes-RCW



▪ LAC02-03 VW-RCW



▪ LAC04-04 VW-AVM



▪ LAC04-08-02 Mercedes-RFK



▪ LAC04-08-02 Mercedes-RFK

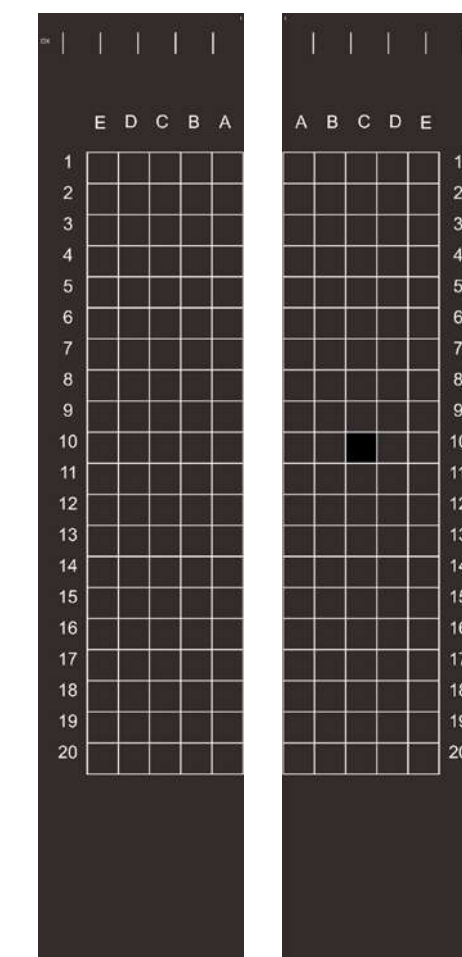

▪ AC04-10-01 Renault-AVM
▪ LAC04-10-02 Renault-AVM



▪ LAC04-14 VW AVM2

Rear Camera & AVM Panels (Asian)

Coverage:

Honda, Nissan, Hyundai, Mitsubishi, Nissan

Package Size:

1280x655x255mm (50*26*10 inch)

Weight:

30.6kg (67 ib)

Rear Camera & AVM Panels (European)

Coverage:

Mercedes, VW, Renault

Package Size:

1280x655x255mm (50*26*10 inch)

Weight:

27.3 kg (60 ib)

Night Vision System(NVS)



- Audi,GM,VW
LAC06-01



- Mercedes
LAC06-02



- Nissan-RCW
LAC04-24



- Toyota-RCW
LAC04-25



- Toyota-AVM
LAC04-16-1



- Toyota-AVM
LAC04-16-2

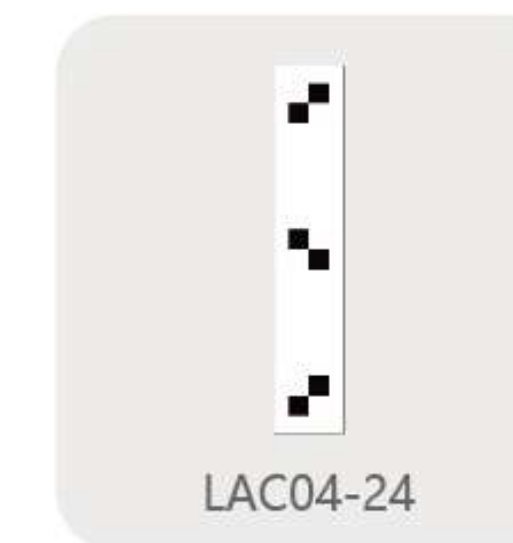

- Toyota-AVM
LAC04-16-3



- Toyota-AVM
LAC04-16-4

Lidar Target

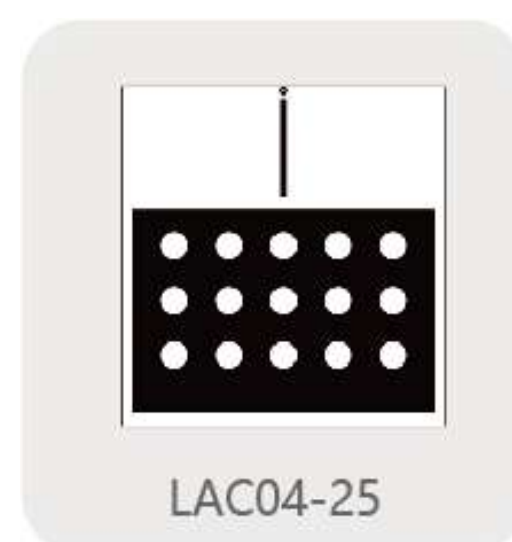

- Audi,VW
LAC05-06

Lane Departure Warning (LDW)



- Sprinter LDW
LAM01-23-L



- Sprinter LDW
LAM01-23-R

Other Target

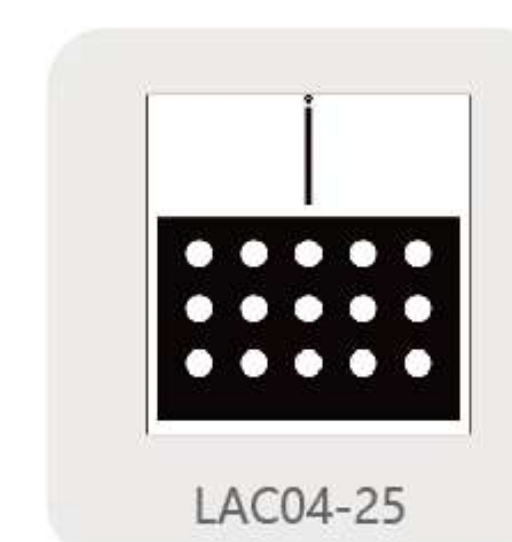

- Honda-Lane Watch
LAC04-17

OPERATION STEPS

STEP 1: Set up your TOPDON PHOENIX ADAS Mobile



STEP 2 : Active the ADAS System in your Phoenix Diagnostics Tablet

Follow the steps below to activate.

- A. Press the POWER button on the diagnostic tool to turn it on.
- B. Tap the "ADAS" icon to view the following screen:

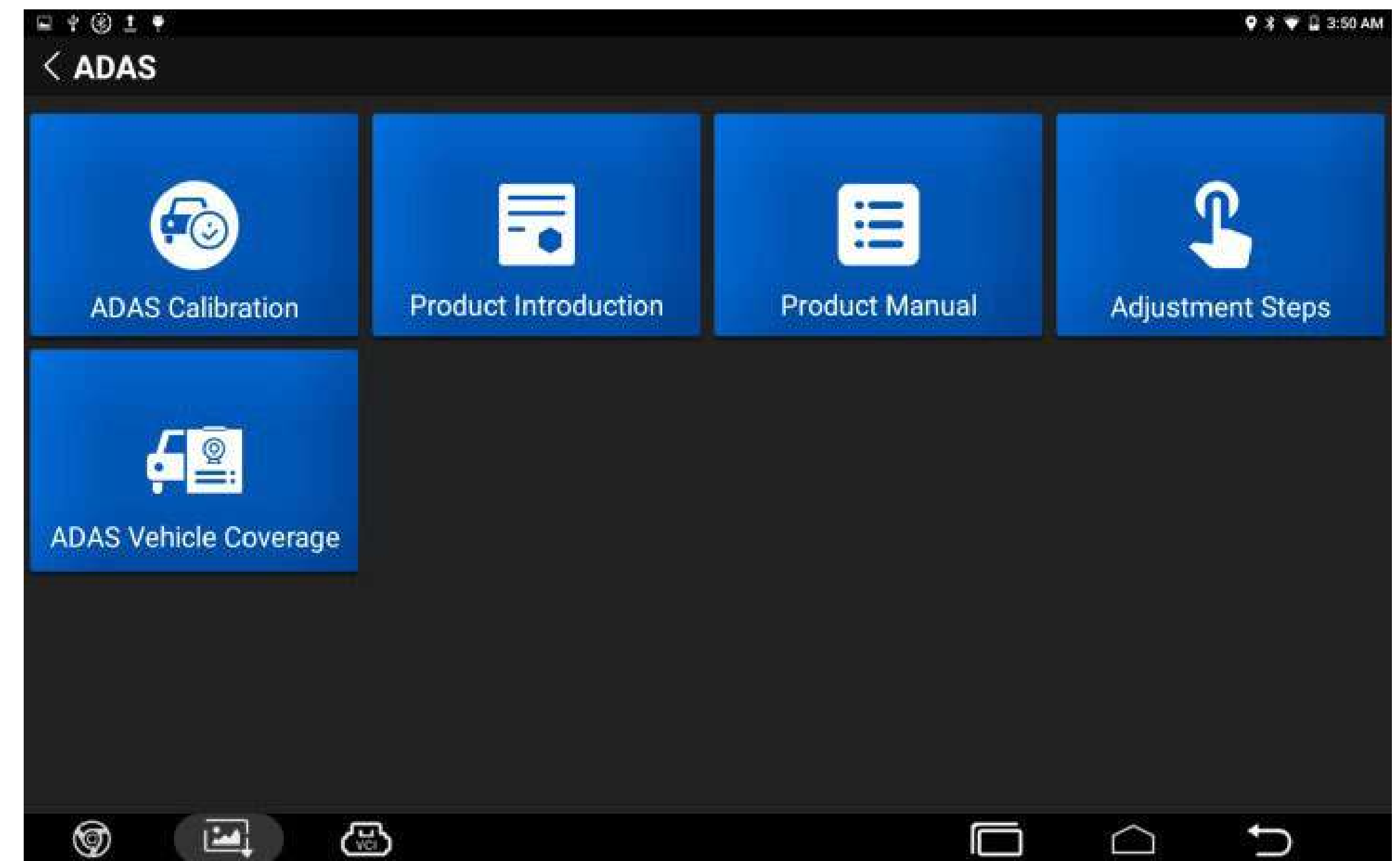

*This picture is for reference only.

STEP 2 : Active the ADAS System in your Phoenix Diagnostics Tablet

A. Tap ADAS Calibration to view the ADAS activation screen.

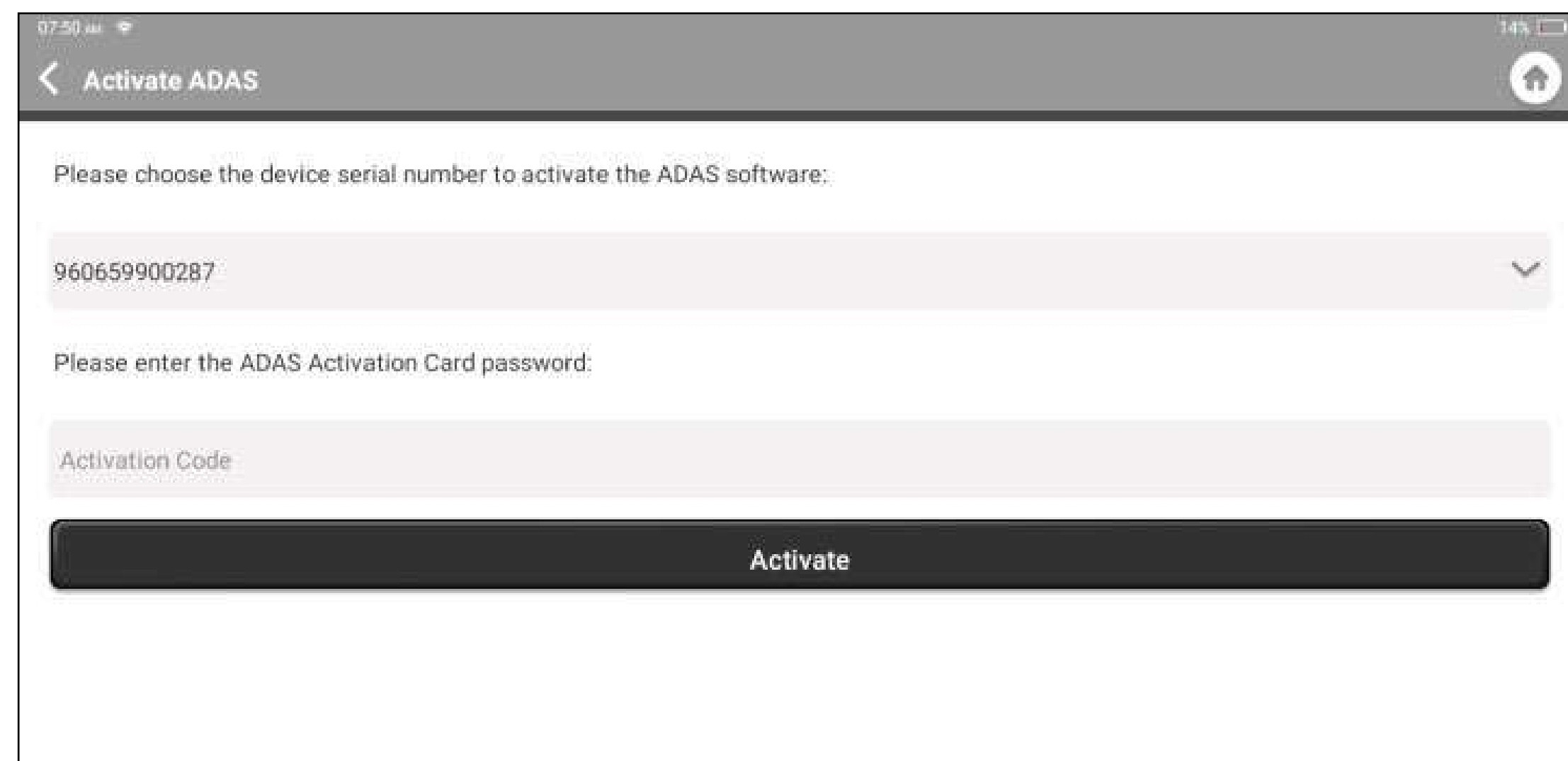

The screenshot shows the 'Activate ADAS' screen on a tablet. At the top, there is a back arrow and the text 'Activate ADAS'. Below this, the instruction reads: 'Please choose the device serial number to activate the ADAS software:'. A dropdown menu is open, showing the serial number '960659900287'. Below that, the instruction reads: 'Please enter the ADAS Activation Card password:'. There is a text input field labeled 'Activation Code'. At the bottom of the screen is a large black button with the text 'Activate' in white.

B. Scratch the designated area on the Activation Card included in your Phoenix ADAS Mobile Package to reveal the password. Then input the 24-digit password to activate it.

C. After completing all these steps, the ADAS calibration function should be ready for use.

STEP 3 : Perform the pre-calibration preparation

Plug your diagnostic scanner's VCI into the car's DLC port, and use the diagnostic tool to identify the vehicle model.



STEP 4 : Start Calibrating the ADAS System

Choose the ADAS system you want to calibrate, and follow the on-screen instructions until the calibration process it's completed.

*This procedure varies depending on which diagnostic scanner you are using. The step-by-step access to the ADAS function can differ.

*For more precise details, please refer to the user manual of each individual scanner.

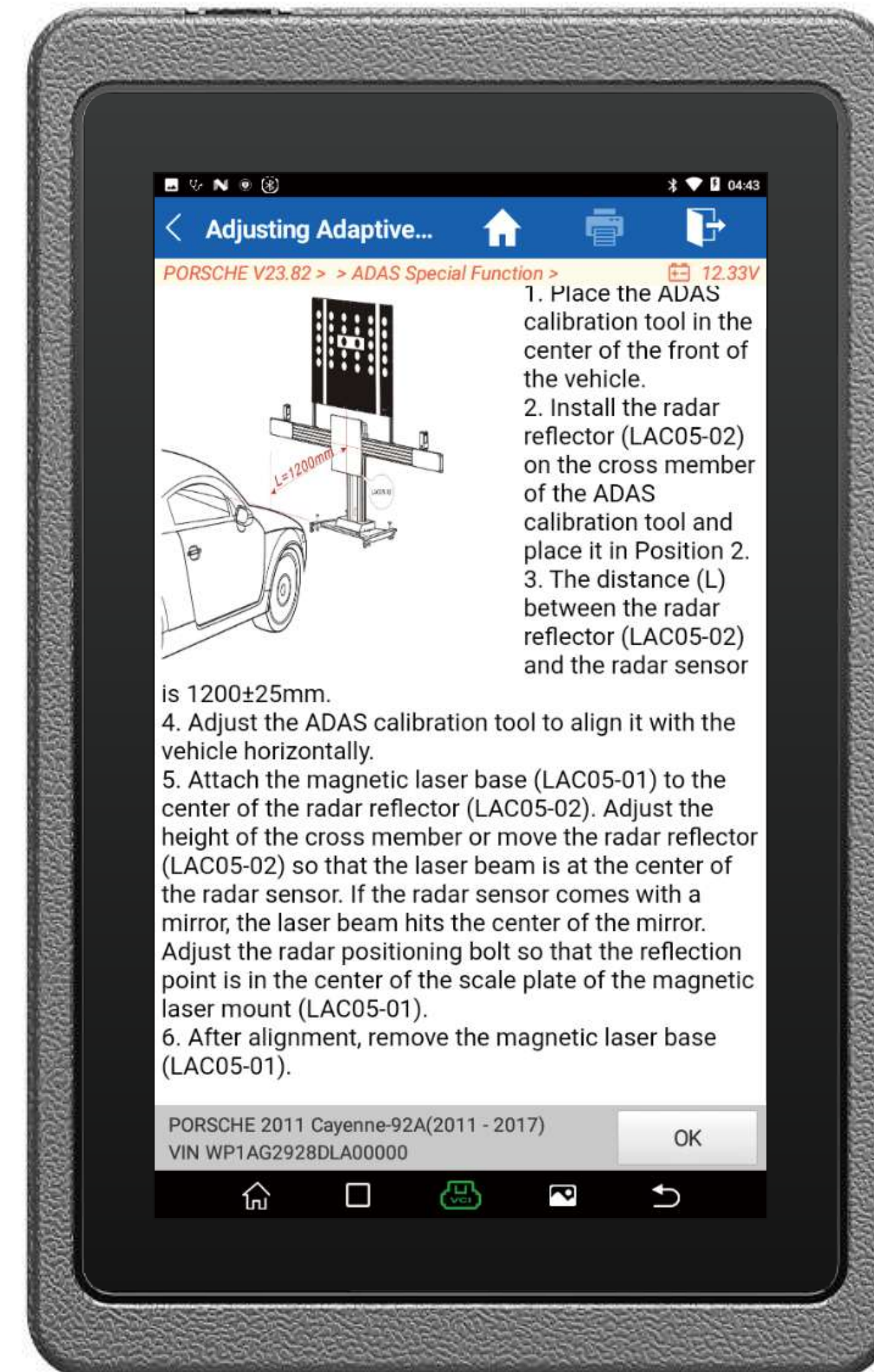

WORKPLACE REQUIREMENTS

Work Station Specifications

- When calibrating the rear & AVM camera, the workstation's ideal size depends on the vehicle's size and calibration reference pattern.
- The image below shows the minimum workstation size for reference only.

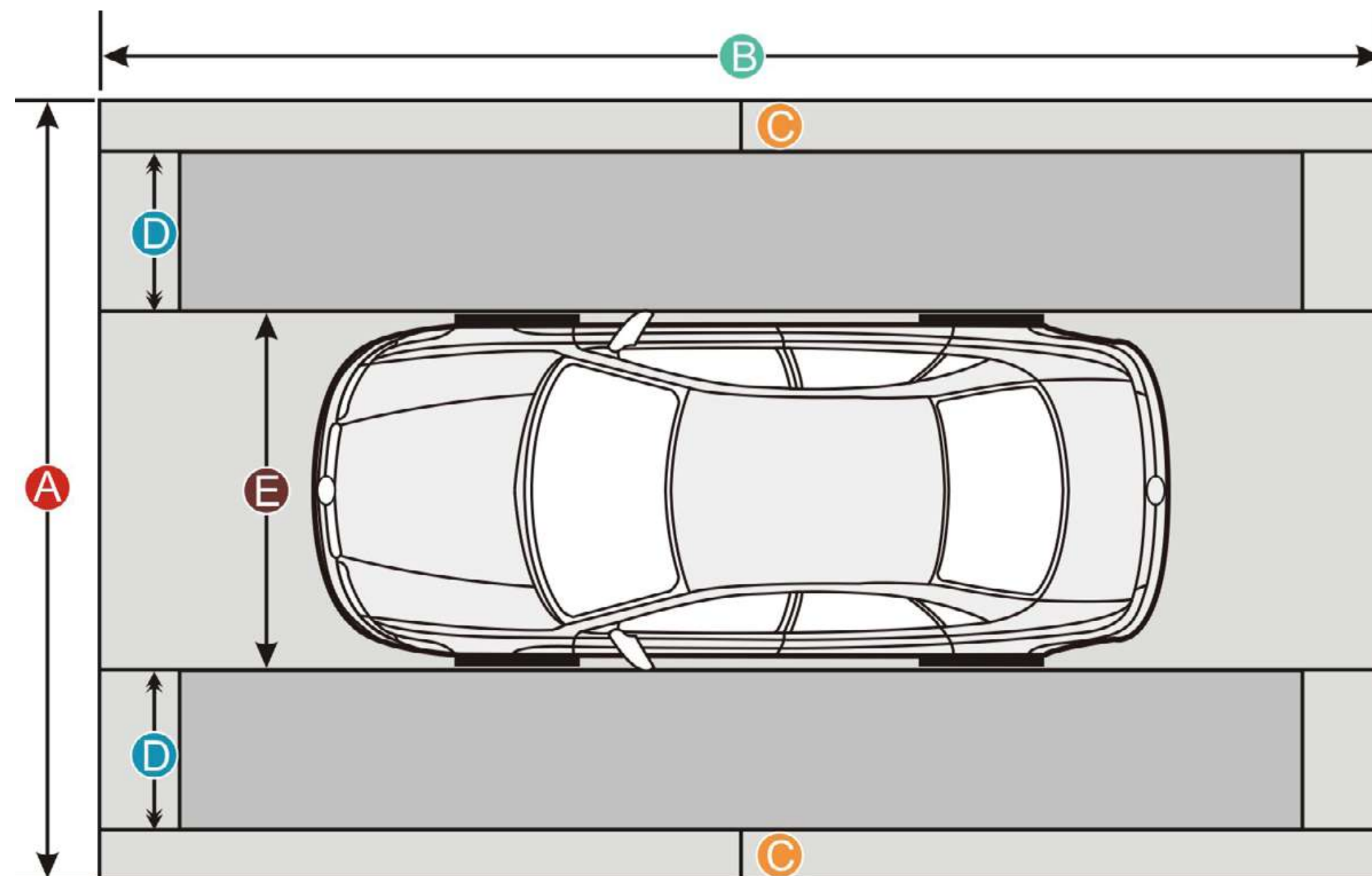

	American vehicles	European vehicles	Asian vehicles
Distance A (the width of the whole workstation)	about 7.3m (287.4inch)	about 4.5m (117.2inch)	about 6.1m (240inch)
Distance B (the width of the whole workstation)	about 12m (472inch)	about 7m (275.6inch)	about 9.5m (374inch)
Distance C (a lane for the technician to walk through)	at least 0.5m (19.7inch)	at least 0.5m (19.7inch)	at least 0.5m (19.7inch)
Distance D (the width of the calibration reference pattern varies from vehicle to vehicle)	about 1.7m (67inch)	about 0.8m (31.5inch)	about 1.6m (63inch)
Distance E (the width of the vehicle varies)	about 2.9m (114inch)	about 1.9m (74.8inch)	about 1.9m (74.8inch)

FAQs

Q How Does ADAS Work?

A ▪ The ADAS (Advanced Driver Assistance System) uses image processing cameras, radar, light detection, and other sensors to monitor the vehicle's surroundings and detect potentially dangerous situations. The purpose is to increase safety through advanced situational awareness and reduce collision possibilities. Sensors used in ADAS include cameras, radars, lasers, and ultrasound. They can detect light, heat, pressure, and other variables used to monitor the vehicle. Usually, they are located in the front and rear bumpers, side mirrors, vehicle cab, and windshield glasses.

Q When to Calibrate an ADAS System?

A ▪ When repairing a vehicle after an accident, the calibration of the relevant auxiliary systems needs to be performed. When disassembling or reinstalling monitoring components such as cameras, radars, and sensors, replacing the vehicle ECU, or the vehicle height, the auxiliary and other systems will also need to be calibrated.



Q What is the ADAS Front-view Camera?

A

- The front-view camera captures what is in front of the vehicle. It's used in a number of ADAS Systems, including Lane Departure Warning (LDW), Lane Keeping Assist (LKA), and Traffic Sign/Signal Recognition (TSR) - often in conjunction with other sensors, cameras, or sensing systems to provide input data.

Q How Can I Get the ADAS Calibration Software?

A

- To get an ADAS calibration software, you can purchase a Phoenix diagnostics scanner or upgrade your existing Phoenix tablet.

- Upgrade Instructions: The Phoenix ADAS mobile accessories come with an activation card, including a password. Simply tap on the tablet's ADAS menu to activate the calibration function. The ADAS Mobile is compatible with the entire Phoenix Line.



Q Which Vehicle Actions Require ADAS System Diagnostics or ADAS Sensor Calibration?

A

- Anything that affects the calibrated sensors. The most common needs for recalibration include collisions, window, bumper, hood, or trunk damage, mirror replacements, suspension work, module replacement, direct damage to a sensor, sensor replacements, and wheel alignments.

Q What are the Different Types of ADAS Calibrations and Are They Brand Specific?

A

- This depends on each vehicle. For most modern cars, either Stationary or Dynamic calibration procedures are required. Some cars, for instance, might require both.
 - Stationary calibrations are performed in a shop environment and require the use of targets or patterns.
 - Dynamic calibrations require the vehicle to be driven on roadways for a certain amount of time with well-maintained road markings.
 - When paired with a Phoenix scanner, technicians can perform both stationary and dynamic calibrations.



Q If I Want to Add individual Targets later, are They Available for Purchase?

A ▪ Yes, the specialty fixtures, existing targets, and new vehicle coverage targets are available for individual purchase.

Q Do I Need Someone to Assemble and/or Set Up the Calibration Frame?

A ▪ No, the complete assembly is simple and it should take about 30 minutes. Visual instructions and standard screws are included in your Phoenix ADAS Mobile Package.



CONTACT US FOR MORE DETAILS

TOPDON®

www.topdon.com

sales@topdon.com

support@topdon.com

Social Media: [@topdonofficial](#)

+1-833-629-4832(North America)

+86-755-21612590

CHINA TOPDON HQ

Unit 2005 20/F, No.3040 xinghai Avenue,
Qianhai Shimao Tower, Qianhai Shenzhen-Hongkong
Cooperation Zone, Shenzhen, PR, China 518000

USA TOPDON HQ

400 Commons Way, Suite A
Rockaway, NJ 07856

